

Combination Treatment

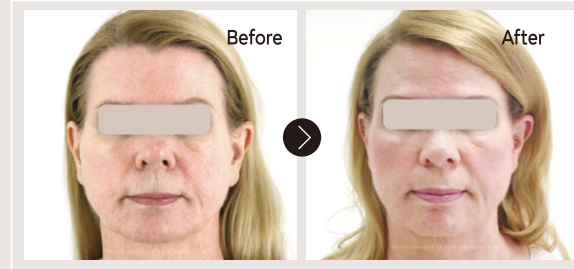

[HIFU + FRM +GFR]



[HIFU + FRM +GFR]



[HIFU + GFR]

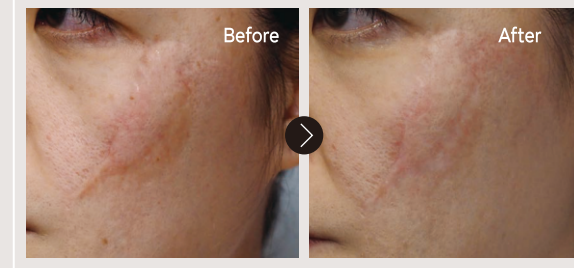

[HIFU + FRM]



[FRM + SRR]

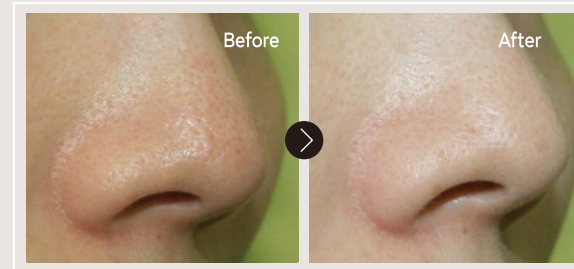

[FRM + SRR]

Single Treatment

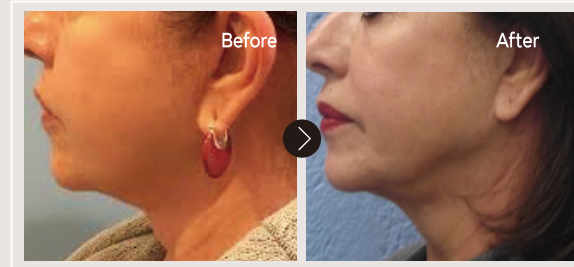

[HIFU]

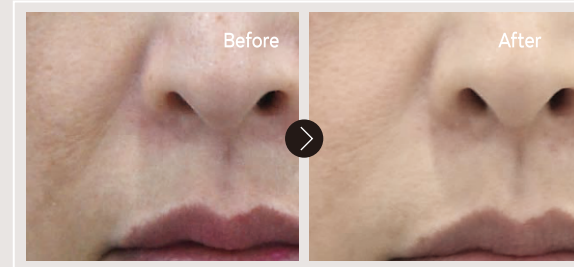

[HIFU]



[FRM]

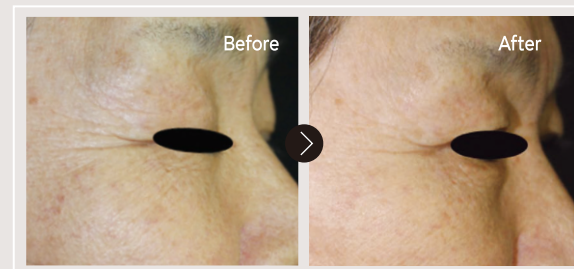

[GFR]

ULTRAcel™

Technical Specification

FRM	Applied Energy	6Mhz RF
	RF Type	Bipolar, Monopolar
	Maximum Output Power	12-60 watt
	Depth Control	0.5mm, 0.8mm, 1.5mm, 2.0mm
GFR	Needle Type	FRM tip, SRR tip, SRT™ tip
	Applied Energy	6MHz RF
	RF Type	Monopolar
HIFU	Maximum Output Power	200 watt
	Tip Type	15 x 15mm, 7x7mm
	Frequency	7MHz
	Maximum Output Power	3J /cm ²
	Cartridge	UQ1.5, UQS2.0, UQ3.0, UQ4.5
	Spacing	1 ~ 2mm(0.1mm/step)
Length	5 ~ 25mm(5mm/step)	

System Specification

Weight	40.5 Kg
Dimensions	982.8mm(H) X 357mm(W) X 408.3mm(L)



For Export 180320 005

Skinnovation Pvt. Ltd.
 Skinnovation House, 83, Plot no.14, Marol Co-op Industrial Estate, Sir Mathuradas VasANJI Road, Andheri East, Mumbai, Maharashtra 400059
 Tel : 022-41531000, Email : info@skinnovation.in, Web : www.skinnovation.in

Jeisys
Better You

Aesthetics Awards

Highly Commended Treatment

ULTRAcel™
 Best Value Combination Treatment Platform



ULTRAcel™

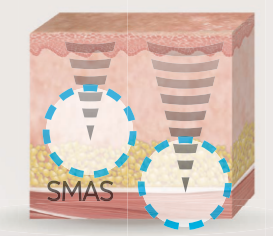
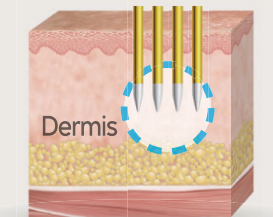
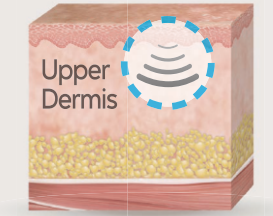
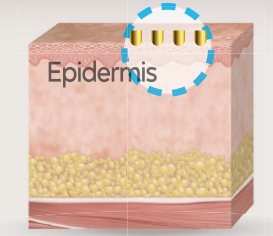

01 Epidermis Superficial RF Rejuvenation



SRR Tip
49 non-invasive needles

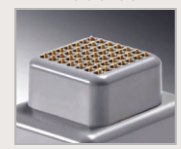

Fine Wrinkles, Skin Tone & Texture

02 Upper Dermis Grid Fractional RF



GFR Tip
7 X 7mm Tip 15 X 15mm Tip



Nasolabial Folds, Tightening, Acne, Periorbital Wrinkles

03 Dermis Fractional RF Microneedling



FRM Tip 49 insulated needles
SRT™ Tip 16 non-insulated needles



Acne, Acne Scars, Stretch Marks, Pores, Skin & Decolletage Rejuvenation

04 SMAS High Intensity Focused Ultrasound



HIFU Cartridge
UQ 1.5 Cartridge UQS 2.0 Cartridge



UQ 3.0 Cartridge UQ 4.5 Cartridge

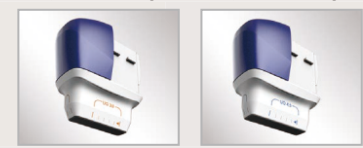

Volume Reduction, Wrinkles, Lifting, Tightening, Double Chin

All in ONE for Combination Treatment

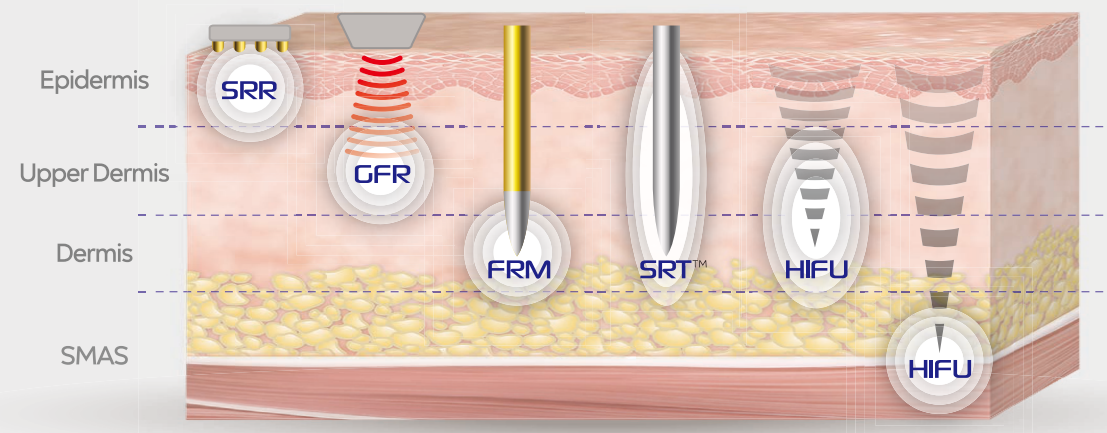

• Real-time MSR (Measuring Skin Resistance)

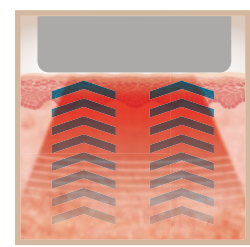

RF energy irradiation
↓
Skin resistance monitoring and instant feedback
↓
Optimal energy delivery

• SRT™ (Selective RF Thermolysis) by Non-insulated needles

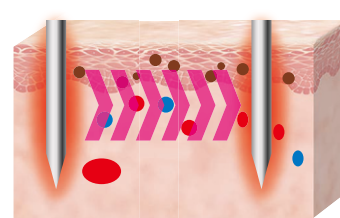

Selective coagulation around vessels between needles due to different conductivity of each tissue
↓
Anti-angiogenetic effect, inhibit melanin growth
↓
Improvement on melasma & flushing

• ULTRA Quick & Slim HIFU



Incomparable Speed

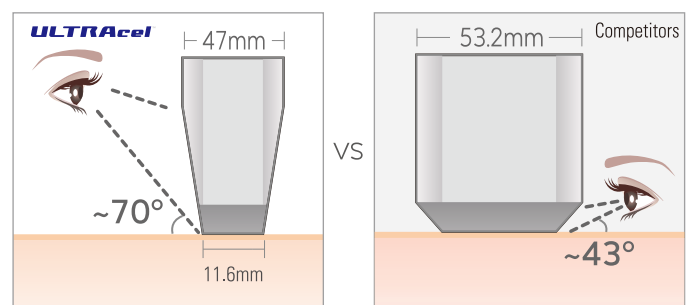

Better Visibility